

## Features and Benefits

- Glass Passivated Die Construction
- Super-Fast Recovery Time for High Efficiency
- $\pm 2$ kV ESD Protection (IEC61000-4-2, Contact Discharge)
- **Lead-Free Finish; RoHS Compliant (Notes 1 & 2)**
- **Halogen and Antimony Free. "Green" Device (Note 3)**

## Mechanical Data

- Case: PowerDI<sup>®</sup> 123
- Case Material: Molded Plastic, "Green" Molding Compound. UL Flammability Classification Rating 94V-0
- Moisture Sensitivity: Level 1 per J-STD-020
- Terminal Connections: Cathode Band
- Terminals: Finish – Matte Tin Annealed over Copper Leadframe. Solderable per MIL-STD-202, Method 208 <sup>(3)</sup>
- Weight: 0.01 grams (Approximate)



Top View

## Ordering Information (Note 4)

Device	Packaging	Shipping
DFLU1200-7	PowerDI123	3000/Tape & Reel

- Notes:
1. EU Directive 2002/95/EC (RoHS) & 2011/65/EU (RoHS 2) compliant. All applicable RoHS exemptions applied.
  2. See [http://www.diodes.com/quality/lead\\_free.html](http://www.diodes.com/quality/lead_free.html) for more information about Diodes Incorporated's definitions of Halogen- and Antimony-free, "Green" and Lead-free.
  3. Halogen- and Antimony-free "Green" products are defined as those which contain <900ppm bromine, <900ppm chlorine (<1500ppm total Br + Cl) and <1000ppm antimony compounds.
  4. For packaging details, go to our website at <http://www.diodes.com/products/packages.html>.

## Marking Information

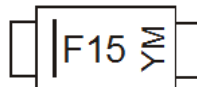

F15 = Product Type Marking Code  
 YM = Date Code Marking  
 Y = Year (ex: E = 2017)  
 M = Month (ex: 9 = September)

### Date Code Key

Year	2005	...	2013	2014	2015	2016	2017	2018	2019	2020	2021	2022
Code	S	...	A	B	C	D	E	F	G	H	I	J

Month	Jan	Feb	Mar	Apr	May	Jun	Jul	Aug	Sep	Oct	Nov	Dec
Code	1	2	3	4	5	6	7	8	9	O	N	D

**Maximum Ratings** (@T<sub>A</sub> = +25°C, unless otherwise specified.)

Single phase, half wave, 60Hz, resistive or inductive load.  
For capacitive load, derate current by 20%.

Characteristic	Symbol	Value	Unit
Peak Repetitive Reverse Voltage	V <sub>RRM</sub>	200	V
Working Peak Reverse Voltage	V <sub>RWM</sub>		
DC Blocking Voltage	V <sub>R</sub>		
RMS Reverse Voltage	V <sub>R(RMS)</sub>	140	V
Average Rectified Output Current (See Figure 4)	I <sub>O</sub>	1.0	A
Non-Repetitive Peak Forward Surge Current 8.3ms Single Half Sine-Wave Superimposed on Rated Load	I <sub>FSM</sub>	30	A

**Thermal Characteristics**

Characteristic	Symbol	Typ	Max	Unit
Power Dissipation (Note 6) @ T <sub>A</sub> = +25°C	P <sub>D</sub>	—	1.0	W
Thermal Resistance Junction to Soldering Point (Note 7)	R <sub>θJS</sub>	—	6	°C/W
Thermal Resistance Junction to Ambient (Note 6) @ T <sub>A</sub> = +25°C	R <sub>θJA</sub>	116	—	°C/W
Thermal Resistance Junction to Ambient (Note 8) @ T <sub>A</sub> = +25°C	R <sub>θJA</sub>	182	—	°C/W
Operating and Storage Temperature Range	T <sub>J</sub> , T <sub>STG</sub>	-65 to +150		°C

**Electrical Characteristics** (@T<sub>A</sub> = +25°C, unless otherwise specified.)

Characteristic	Symbol	Value	Unit
Minimum Reverse Breakdown Voltage @ I <sub>R</sub> = 5μA	V <sub>(BR)</sub>	200	V
Maximum Forward Voltage Drop @ I <sub>F</sub> = 0.6A @ I <sub>F</sub> = 1.0A	V <sub>FM</sub>	0.90	V
		0.98	
Peak Reverse Current @ T <sub>A</sub> = +25°C at Rated DC Blocking Voltage (Note 5) @ T <sub>A</sub> = +100°C	I <sub>RM</sub>	5.0	μA
		200	
Reverse Recovery Time (Note 9)	t <sub>RR</sub>	25	ns
Typical Total Capacitance (f = 1MHz, V <sub>R</sub> = 4VDC)	C <sub>T</sub>	27	pF

- Notes:
- Short duration pulse test used to minimize self-heating effect.
  - Device mounted on 1" x 1", Polyimide PCB; 2 oz. Cu pad layout as shown on Diodes Incorporated's website <http://www.diodes.com/package-outlines.html>.
  - Theoretical R<sub>θJS</sub> calculated from the top center of the die straight down to the PCB cathode tab solder junction.
  - Device mounted on FR-4 PCB, 2 oz. Copper, minimum recommended pad layout per <http://www.diodes.com/package-outlines.html>.
  - Measured with I<sub>F</sub> = 0.5A, I<sub>R</sub> = 1.0A, I<sub>RR</sub> = 0.25A. See figure 7.

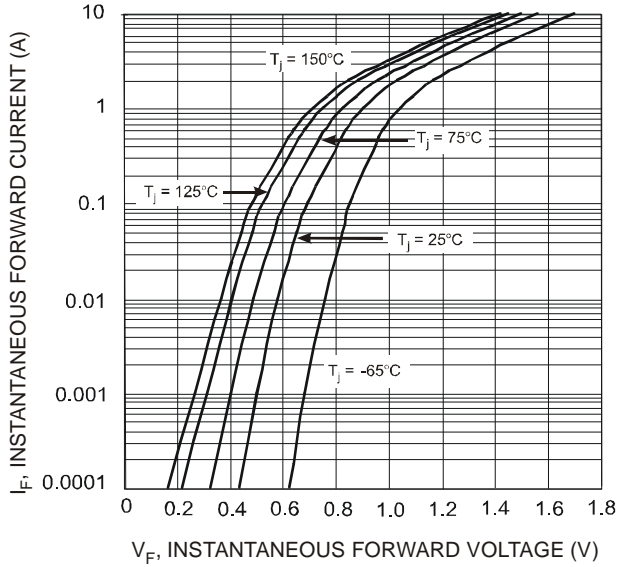

Fig. 1 Typical Forward Characteristics

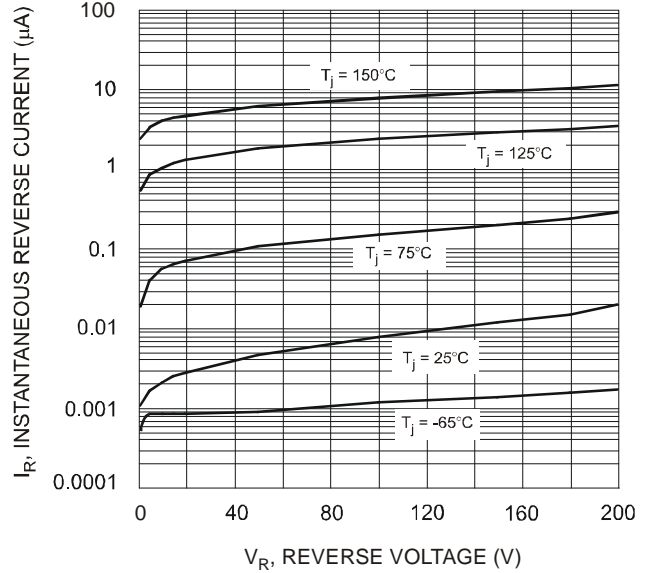

Fig. 2 Typical Reverse Characteristics

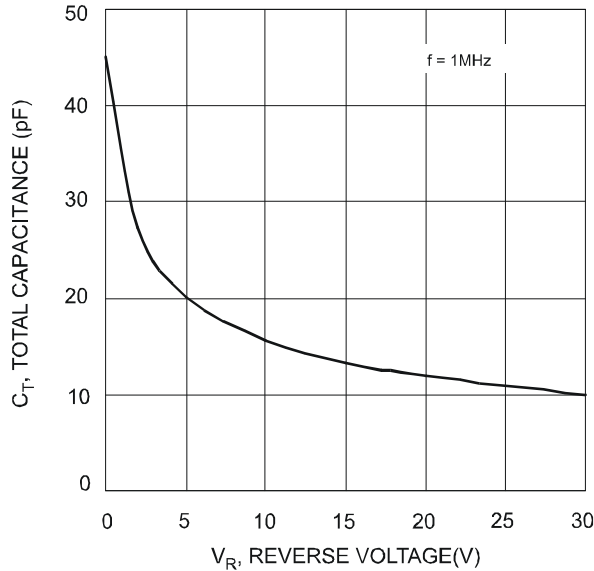

Fig. 3 Typical Total Capacitance

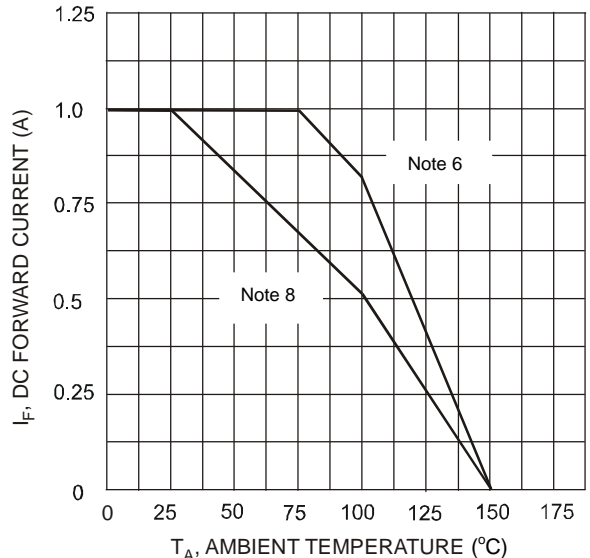

Fig. 4 DC Forward Current Derating

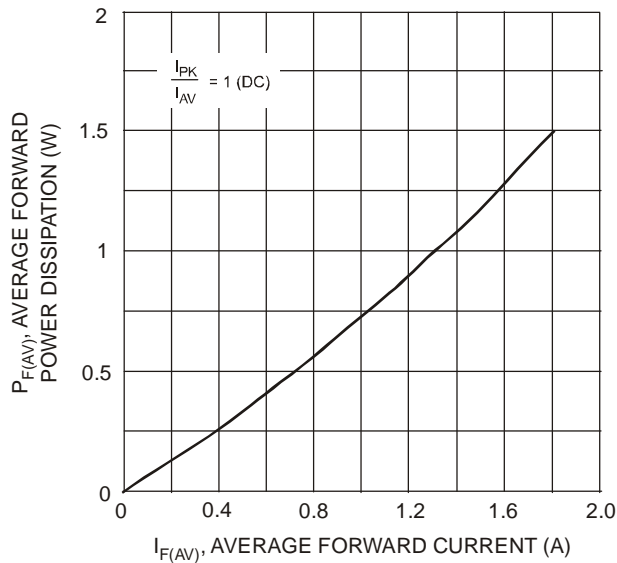

Fig. 5 Forward Power Dissipation

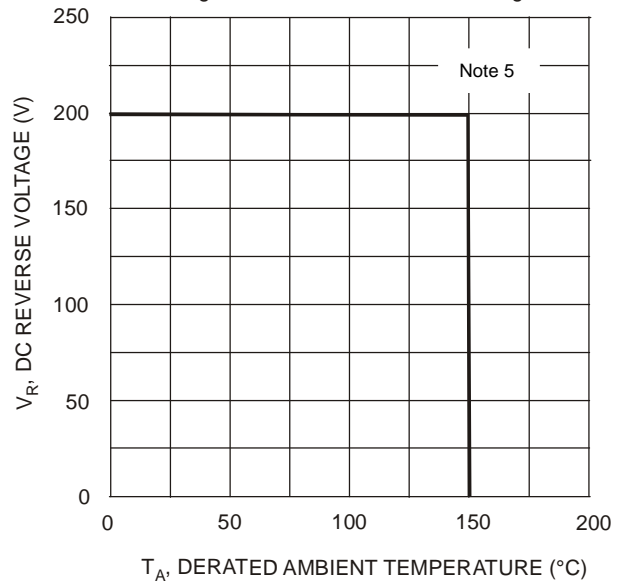
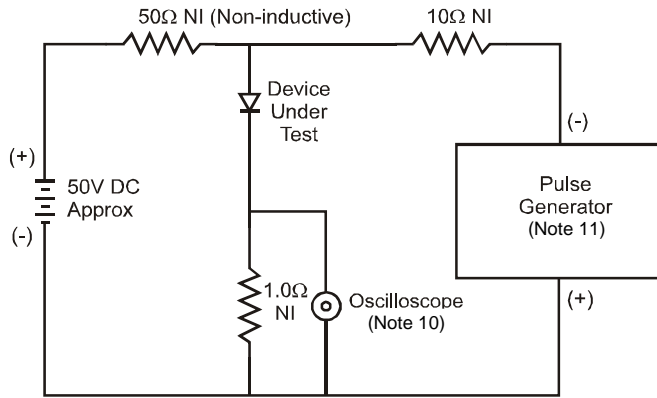
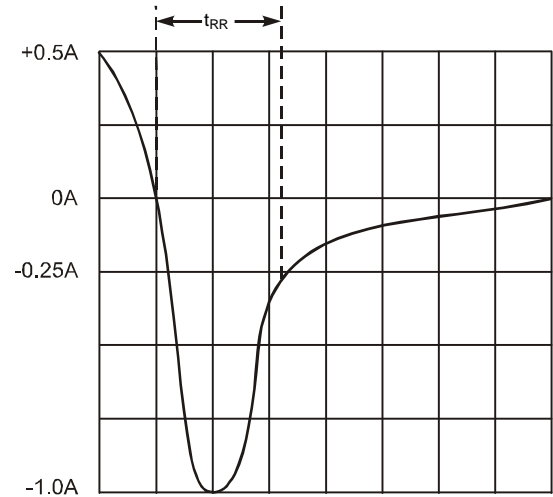

Fig. 6 Operating Temperature Derating



Notes:  
 10. Rise Time=7.0ns max. Input Impedance=1.0MΩ. 22pF.  
 11. Rise Time=10ns max. Input Impedance=50Ω.



Set time base for 50/100 ns/cm

Fig. 7 Reverse Recovery Time Characteristic and Test Circuit

**Package Outline Dimensions**

Please see <http://www.diodes.com/package-outlines.html> for the latest version.

**PowerDI123**

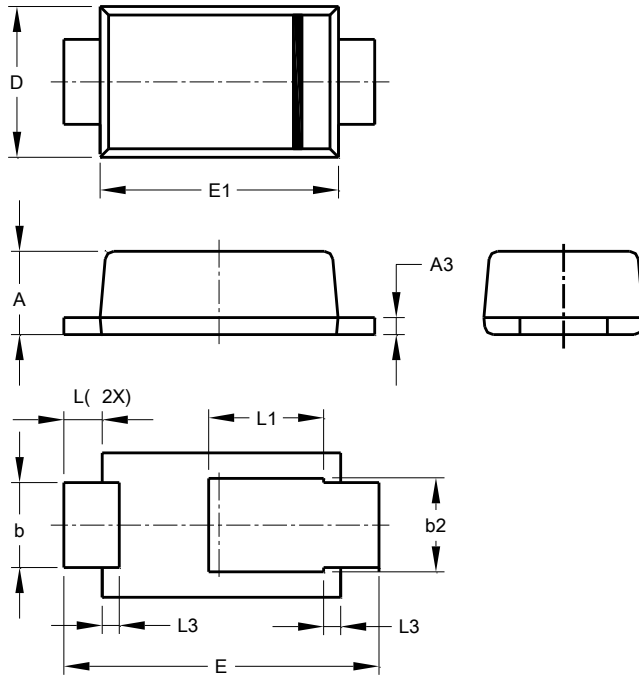

PowerDI123			
Dim	Min	Max	Typ
A	0.93	1.00	0.98
A3	0.15	0.25	0.20
b	0.85	1.25	1.00
b2	1.025	1.125	1.10
D	1.63	1.93	1.78
E	3.50	3.90	3.70
E1	2.60	3.00	2.80
L	0.40	0.50	0.45
L1	1.25	1.40	1.35
L3	0.125	0.275	0.20
All Dimensions in mm			

**Suggested Pad Layout**

Please see <http://www.diodes.com/package-outlines.html> for the latest version.

**PowerDI123**

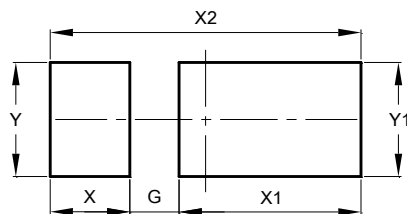

Dimensions	Value (in mm)
G	0.65
X	1.05
X1	2.40
X2	4.10
Y	1.50
Y1	1.50

**IMPORTANT NOTICE**

DIODES INCORPORATED MAKES NO WARRANTY OF ANY KIND, EXPRESS OR IMPLIED, WITH REGARDS TO THIS DOCUMENT, INCLUDING, BUT NOT LIMITED TO, THE IMPLIED WARRANTIES OF MERCHANTABILITY AND FITNESS FOR A PARTICULAR PURPOSE (AND THEIR EQUIVALENTS UNDER THE LAWS OF ANY JURISDICTION).

Diodes Incorporated and its subsidiaries reserve the right to make modifications, enhancements, improvements, corrections or other changes without further notice to this document and any product described herein. Diodes Incorporated does not assume any liability arising out of the application or use of this document or any product described herein; neither does Diodes Incorporated convey any license under its patent or trademark rights, nor the rights of others. Any Customer or user of this document or products described herein in such applications shall assume all risks of such use and will agree to hold Diodes Incorporated and all the companies whose products are represented on Diodes Incorporated website, harmless against all damages.

Diodes Incorporated does not warrant or accept any liability whatsoever in respect of any products purchased through unauthorized sales channel. Should Customers purchase or use Diodes Incorporated products for any unintended or unauthorized application, Customers shall indemnify and hold Diodes Incorporated and its representatives harmless against all claims, damages, expenses, and attorney fees arising out of, directly or indirectly, any claim of personal injury or death associated with such unintended or unauthorized application.

Products described herein may be covered by one or more United States, international or foreign patents pending. Product names and markings noted herein may also be covered by one or more United States, international or foreign trademarks.

This document is written in English but may be translated into multiple languages for reference. Only the English version of this document is the final and determinative format released by Diodes Incorporated.

**LIFE SUPPORT**

Diodes Incorporated products are specifically not authorized for use as critical components in life support devices or systems without the express written approval of the Chief Executive Officer of Diodes Incorporated. As used herein:

A. Life support devices or systems are devices or systems which:

1. are intended to implant into the body, or
2. support or sustain life and whose failure to perform when properly used in accordance with instructions for use provided in the labeling can be reasonably expected to result in significant injury to the user.

B. A critical component is any component in a life support device or system whose failure to perform can be reasonably expected to cause the failure of the life support device or to affect its safety or effectiveness.

Customers represent that they have all necessary expertise in the safety and regulatory ramifications of their life support devices or systems, and acknowledge and agree that they are solely responsible for all legal, regulatory and safety-related requirements concerning their products and any use of Diodes Incorporated products in such safety-critical, life support devices or systems, notwithstanding any devices- or systems-related information or support that may be provided by Diodes Incorporated. Further, Customers must fully indemnify Diodes Incorporated and its representatives against any damages arising out of the use of Diodes Incorporated products in such safety-critical, life support devices or systems.

Copyright © 2017, Diodes Incorporated

**[www.diodes.com](http://www.diodes.com)**